

Profile

- Easy adhesive mounting, self-assembly possible
- Available lengths up to 75 m

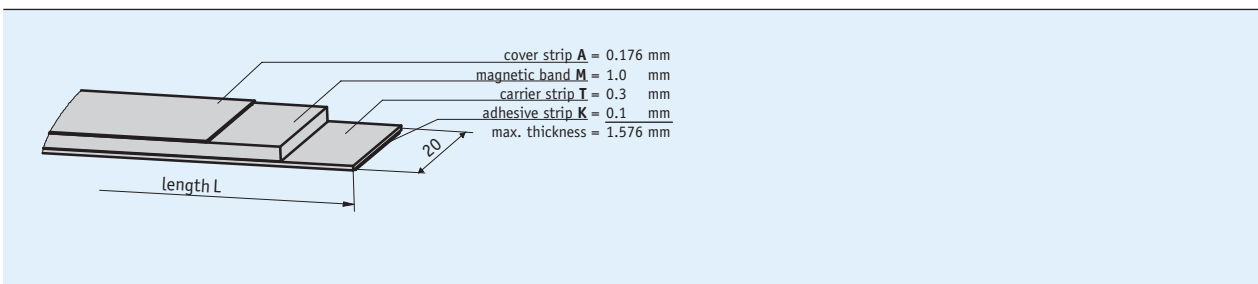
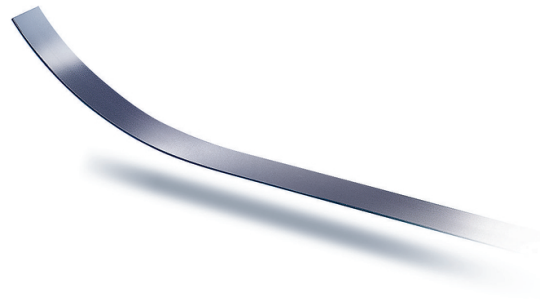

Mechanical data

Feature	Technical data	Additional information
Material	stainless steel	cover strip
Band width	20 mm	
Band thickness	1.4 mm	without cover strip
Mounting type	adhesive connection	double-sided tape premounted
Accuracy class	±100 µm	at T _U = 20 °C

System data

Feature	Technical data	Additional information
Measuring range	≤20480 mm	

Ambient conditions

Feature	Technical data	Additional information
Ambient temperature	-20 ... 70 °C	
Storage temperature	-40 ... 70 °C	
Expansion coefficient	(11 ±1) × 10 ⁻⁶ /K	
Relative humidity	100 %	condensation admissible

Order

■ **Ordering information**

The necessary tape length is calculated from:
Measured distance + sensor length "S" + (2 x forerun or overrun "B", resp.).

S	see the drawing of the sensor used
B	5 mm (forerun and overrun)

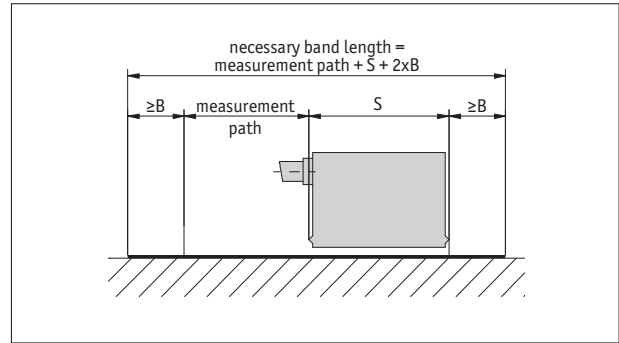

Symbolic representation

■ **Ordering table**

Feature	Ordering data	Specification	Additional information
Length	... A	00.5 ... 75.0 m, in intervals of 0.1 m	ordering detail, see "Ordering information"
Adhesive carrier tape	TM	with	
	TO	without	
Cover strip	AM	with	
	AO	without	

■ **Order key**

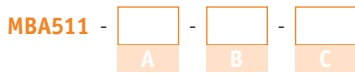

Scope of delivery: MBA511

Accessories:
Profile Rail PSA

www.siko-global.com