

Profile

- Solid shaft \varnothing 6 mm
- Adaptation to various measurement distances owing to a wide range of gear ratios
- Integrated slip clutch to protect the potentiometer
- Compact design
- Potentiometer or power output
- IP65 protection category
- Up to 3 cam-operated switch outputs, freely adjustable

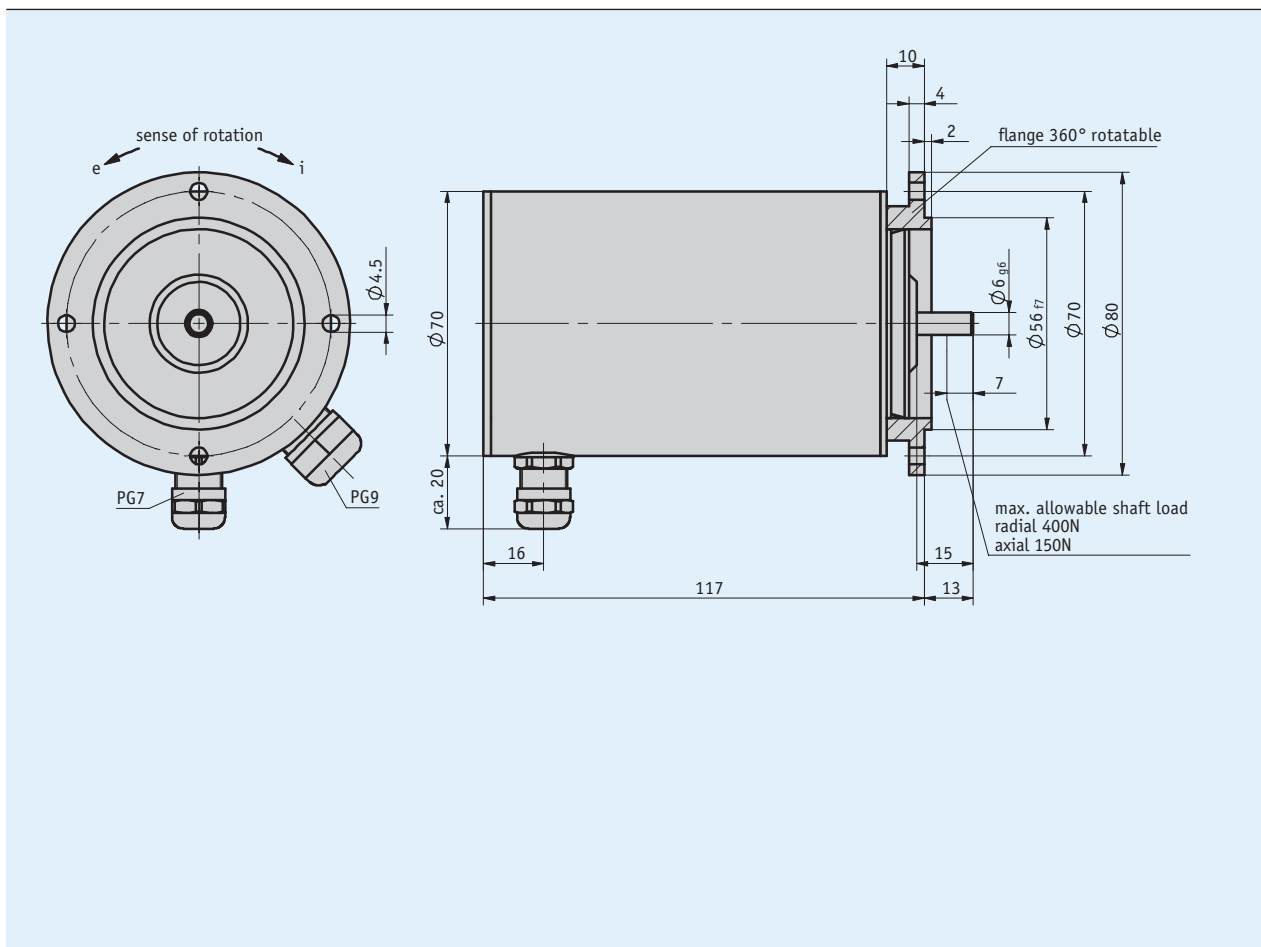

Mechanical data

Feature	Technical data	Additional information
Shaft	black-finished steel	
Housing	aluminum	
Gear ratio	0.1 ... 512	
Speed	≤ 500 rpm	depending on transmission
Shaft load rating	≤ 400 N	radial
	≤ 150 N	axial
Potentiometer service life	1×10^6 revolution(s)	

Electrical data

Encoder potentiometer type 01, 1 helix

Feature	Technical data	Additional information
Power rating	1 W at 70 °C	≤30 V
Resistance	1, 5, 10 kΩ	
Resistance tolerance	±10 %	
Standard terminal resistance	0.5 %	
Linearity tolerance	±1 %	
Design	hybride	

Encoder potentiometer type 02, 10 helices

Feature	Technical data	Additional information
Power rating	2 W at 70 °C	≤30 V
Resistance	1, 5, 10 kΩ	
Resistance tolerance	±5 %	
Standard terminal resistance	0.2 %	
Linearity tolerance	±0.25 %	
Design	wire	

Encoder potentiometer type 03, 10 helices

Feature	Technical data	Additional information
Power rating	2 W at 70 °C	≤30 V
Resistance	1, 5, 10 kΩ	
Resistance tolerance	±5 %	
Standard terminal resistance	0.2 %	
Linearity tolerance	±0.25 %	
Design	hybride	

Encoder potentiometer type 03/0.1, 10 helices

Feature	Technical data	Additional information
Power rating	2 W at 70 °C	≤30 V
Resistance	5, 10 kΩ	
Resistance tolerance	±5 %	
Standard terminal resistance	0.2 %	
Linearity tolerance	±0.1 %	
Design	hybride	

Transducer, power output

Feature	Technical data	Additional information
Operating voltage	24 V DC ±20 %	
Output current	4 ... 20 mA	at ≤500 Ω load

Load capacity of the switching cams

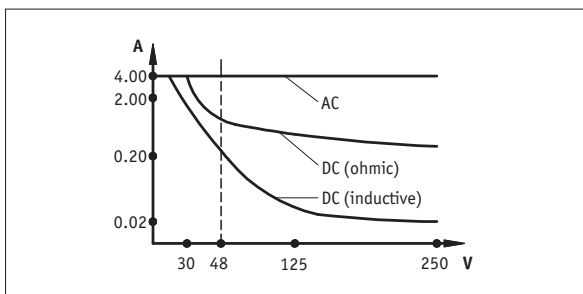

System data

Feature	Technical data	Additional information
Measuring range	340° ±5° (mechanical full-length)	potentiometer type 01
	3600° +10°	potentiometer types 02, 03, 03/0,1

Ambient conditions

Feature	Technical data	Additional information
Ambient temperature	-20 ... 80 °C	
Relative humidity		condensation inadmissible
EMC	EN 61000-6-2	interference resistance / immission
	EN 61000-6-4	emitted interference / emission
Protection category	IP52	EN 60529

Pin assignment

■ Potentiometric outputs P01, P05, P10

Signal	Terminal
Po	11
Pe	13
S	12

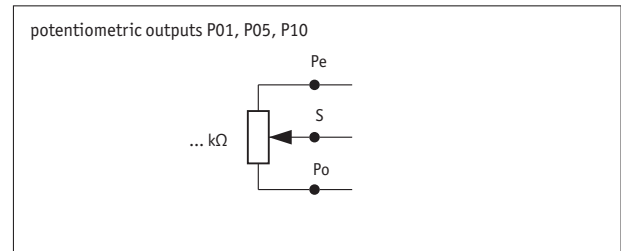

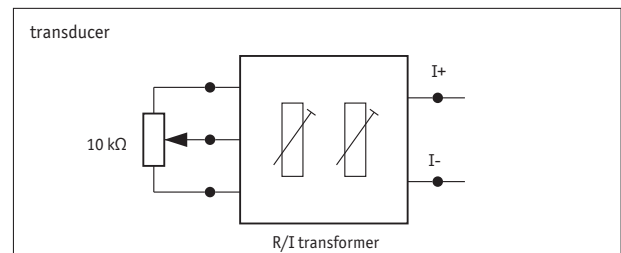

■ MMW transducer

Signal	Terminal
I+	12
I-	11
N.C.	13



■ Cam

Belegung	Switch cam 1 Terminal	Switch cam 2 Terminal	Switch cam 3 Terminal
	1	4	7
	2	5	8
	3	6	9

Order

■ Gear ratio calculation

$$\text{Formula: } i_1 = \frac{n \times 360^\circ}{\alpha}$$

n = number of revolutions on the driving shaft
 α = potentiometer angle of rotation
 340° with 1-coil potentiometer
 3600° with 10-coil potentiometer
 i1 = order feature for gear ratio

If the calculated ratio "i1" is the same as a value in the ordering table for the "ratio" feature, but this is not available, select the next highest ratio.

■ Ordering of switch cam

Digit 1	Digit 2	Digit 3	Ordering data
Cam shape 2			2
Cam shape 1	Cam shape 3		13
Cam shape 1	Cam shape 2	Cam shape 3	123

Example of ordering table, F feature

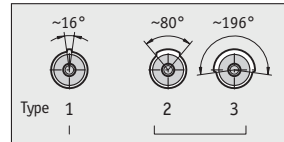

Switching angle of the 3 switching cams:
 specifically for end position limiter (1), for control functions (2, 3).

■ Ordering table

Feature	Ordering data	Specification	Additional information
Gear ratio	...	A 0.1/10, 0.2/10, 0.25/10, 0.333/10, 0.5/10, 0.5/2.5, 1, 1.400, 2, 2.14, 2.500, 3, 4, 5, 5.385, 6, 7, 10, 12, 14, 15, 20, 21, 24, 30, 33, 35, 40, 48, 55, 60.5, 64, 65.154, 70, 80, 96, 101.5, 121, 150, 256, 463.830, 512 others on request	
Potentiometer type	01 02 03 03/0.1	B 1 helix, hybrid 10 helices, wire 10 helices, hybrid 10 helices, hybrid, linear tolerance ±0.1 %	
Resistance	1 5 10	C potentiometer 1 kΩ potentiometer 5 kΩ potentiometer 10 kΩ	
Transducer	MMW OMW	D transducer 4 ... 20 mA without	only for resistance 10 and potentiometer type 02 or 03
Sense of rotation		E no information required e counter-clockwise ascending values i clockwise ascending values	only for OMW transducer only for MMW transducer only for MMW transducer
Cam/form	...	F 1, 2, 3, 11, 12, 13, 22, 23, 33, 111, 112, 113, 122, 123, 221, 222, 223, 233, 331, 333 others on request	
Switching voltage	1 2	G over 48 V electric strength up to 48 V electric strength	

■ Order key



Scope of delivery: GP43, Mounting instructions

Accessories:
 Flexible coupling AK18
 Electronic display MA50

www.siko-global.com
 www.siko-global.com