

Profile

- Freely programmable electronic digital display for length or angular measurement
- Freely programmable via the ProToolDE programming software
- Hollow shaft, max. \varnothing 30 mm
- LCD display with 5 digits and special characters
- Digit height approx. 12 mm
- Reset, incremental measurement, offset via keyboard
- Long battery life
- Easy battery change without dismantling of the device

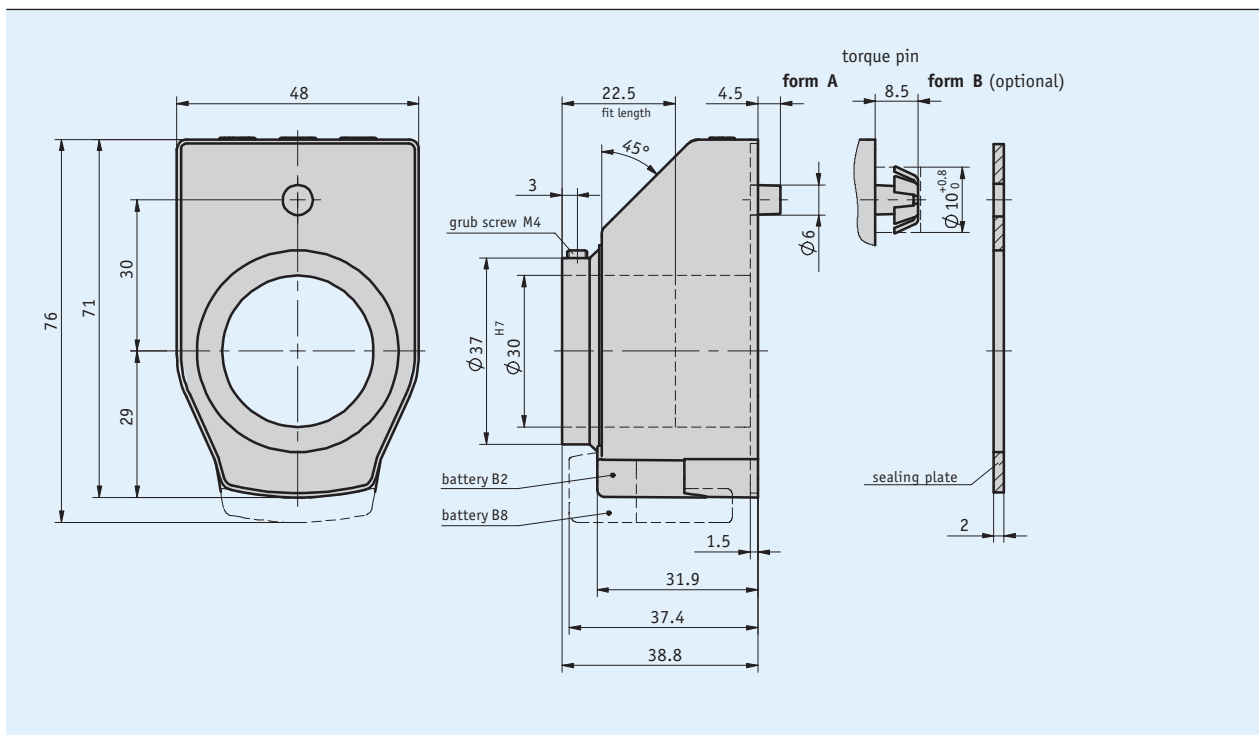

Mechanical data

Feature	Technical data	Additional information
Shaft	black-finished steel (supported in friction bearings)	($\leq \varnothing 30H7$)
Housing	plastic	
Speed	≤ 600 rpm	(100 % ED)
Weight	~ 0.1 kg	

Electrical data





Feature	Technical data	Additional information
Battery	lithium coin cell, 3 V, CR2032 type	~ 2 -year service life
	lithium coin cell, 3 V, CR2477 type	~ 8 -year service life
Display/display range	5-digit LCD 7-segment, ~ 8 mm height	-19999 ... 99999

Ambient conditions

Feature	Technical data	Additional information
Ambient temperature	-10 ... 60 °C	
Storage temperature	-30 ... 80 °C	
EMC	EN 61000-6-2	interference resistance / immission
	EN 61000-6-4	emitted interference / emission
Protection category	IP51	EN 60529
Shock resistance	300 m/s ² , 15 ms	EN 60068-2-27
Vibration resistance	100 m/s ² , 5 ... 150 Hz	EN 60068-2-6
	200 m/s ² , 100 Hz ... 2 kHz	EN 60068-2-6

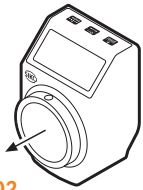
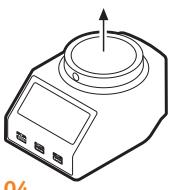
Order

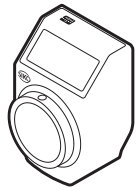
Ordering information

Mounting position		Key pad operation			Counting direction
					
02	04	D/V	K	OF	

Hint: Texts highlighted in orange color are order characteristics.

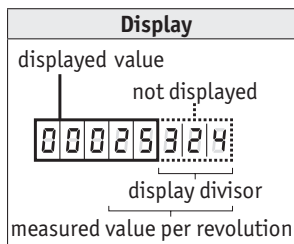

Display divisor

The indication of the measured value on the display can be influenced by means of the divisor (divider). The divisor shifts figures of the measured value into the invisible sector of the display unit. Although the figures are not displayed, they are also calculated by the electronics unit and mathematically rounded.

Calculation of value displayed (example order text):

Measured value per revolution 25324
Display divisor 1000

Feature	Displayed value	Measured value
1st revolution	25	25324
2nd revolution	51	50648
3rd revolution	76	75972

 Please note that the value displayed (=measured value per revolution / display divisor) must be at least 2!

Ordering table

Feature	Ordering data	Specification	Additional information		
Mounting position*	02	A horizontal spindle			
	04			vertical spindle	
Measured value per revolution*	...	B 00002 ... 90000	see display value calculation		
	W3600	angle mode 0° ... 360°, resolution 0.1°	only with comma position "1"		
	Z3600	angle mode -180° ... +180°, resolution 0.1°	only with comma position "1"		
Decimal place*	0	C 0 = 00000			
	1			1 = 0000.0	
	2			2 = 000.00	
	3			3 = 00.000	
Display divisor*	...	D 1, 10, 100, 1000	see display value calculation		
Counting direction*	i	E clockwise ascending values			
	e			counter-clockwise ascending values	
Key pad operation	D	F direct zeroing*			
	V			zeroing delayed by 5 s*	
	K			only incremental measurement function	
	0F			without function keys	
Hollow shaft/diameter	30	G ø30 mm			
	20			ø20 mm	
	...			RH16, RH22, RH24, RH25, RH25.4, RH26	reducing bushes
				others on request	
Color	0	H orange RAL 2004			
	S			black RAL 9005	
Battery	B2	I ~2 years service life			
	B8			~8 years service life	observe technical drawing

* Programmable via ProTool DE programming software

Order key

DE10 - - - - - - - - - - - - -

A B C D E F G H A BP I

Scope of delivery: DE10, Mounting instructions

Accessories:

Programming software ProTool DE
 Reduction sleeve RH
 Pneumatic clamping plate KP09P
 Clamping plate KPL09

www.siko-global.com
www.siko-global.com
www.siko-global.com
www.siko-global.com