

# INSTALLATION INSTRUCTIONS

## STEP 1

REMOVE KEEPER INSERT FROM KEEPER BY REMOVING SCREW. (PROVIDED)  
 INSTALL KEEPER INSERT AS SHOWN INTO FRAME/PANEL USING RECOMMENDED TWO No.10 OR M5 SCREWS (NOT PROVIDED).  
 RE-ASSEMBLE KEEPER AND KEEPER INSERT.

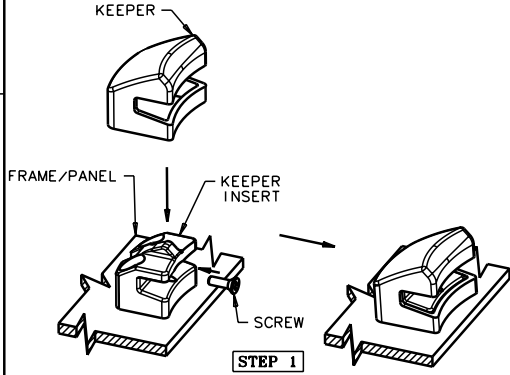

## STEP 2

UNSCREW HANDLE BASE TO INSTALL SCREWS TO FASTEN BASE TO DOOR.

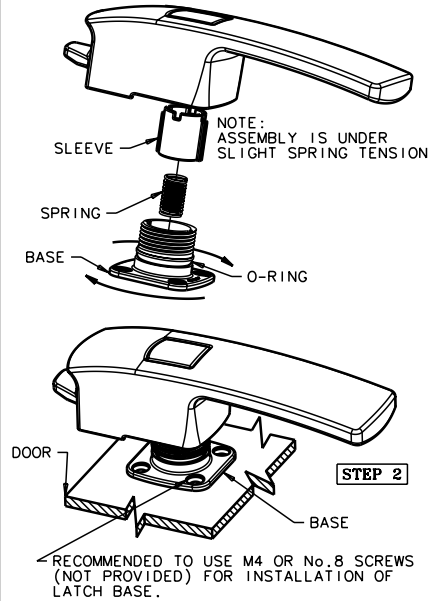

## STEP 3

PUSH DOWN BUTTON ON HANDLE AND ROTATE HANDLE UNTIL PAWL IS ALIGNED WITH KEEPER. (SEE NOTE B)  
 BE SURE SLEEVE IS ORIENTED PROPERLY.

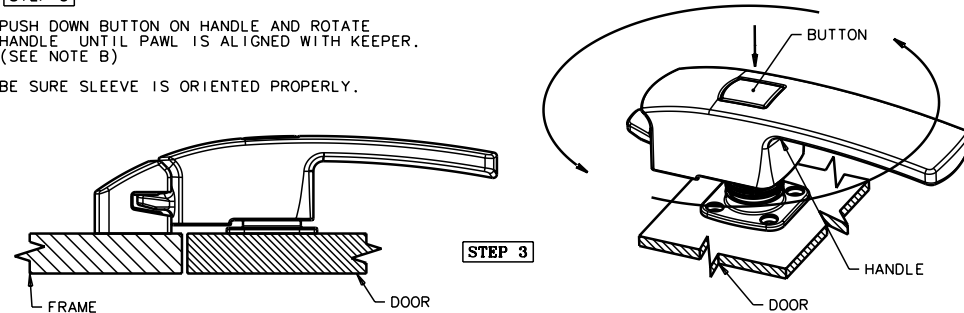

### NOTES:

#### A. MATERIAL AND FINISH:

HANDLE, KEEPER, BASE, BUTTON AND SLEEVE - CF-8M STAINLESS STEEL (NOMINAL CAST EQUIVALENT OF 316 STAINLESS STEEL), ELECTROPOLISHED.

KEEPER INSERT - PA6, BLACK

O-RING - EPDM, NATURAL.

SCREW, SPRING, NUT - 304 STAINLESS STEEL, PASSIVATED

#### B. PAWL AND KEEPER ALIGNMENT:

TO INCREASE THE HEIGHT OF THE LATCH BY .375 [.0156], ROTATE THE BASE 90° CLOCKWISE.

TO DECREASE THE HEIGHT OF THE LATCH BY .375 [.0156], ROTATE THE BASE 90° COUNTER CLOCKWISE.

FOR EVERY 360° TURN, THE HEIGHT ADJUSTS 1.5 [.0625].

REVISION HISTORY			
REV	DATE	BY	DESCRIPTION
A	07MAY2009	RLR/AR	PRN: P2009-0584

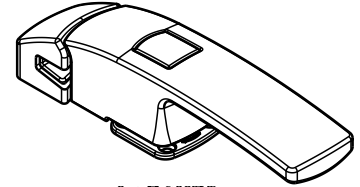
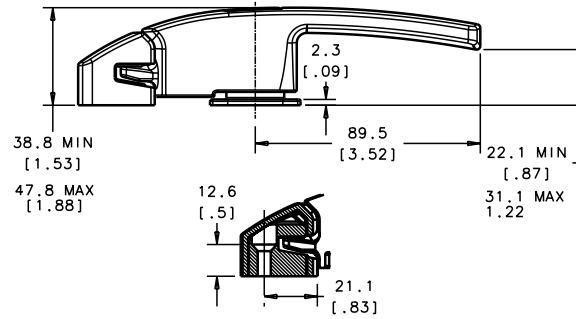
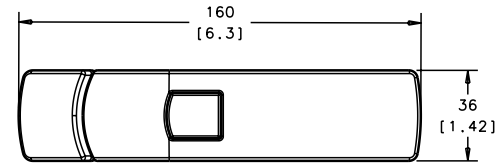

LATCHED

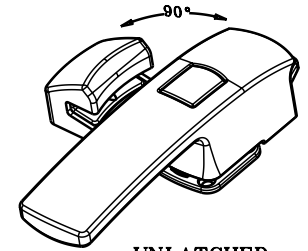

UNLATCHED

ABLE TO ROTATE 90° IN EITHER DIRECTION FROM KEEPER.

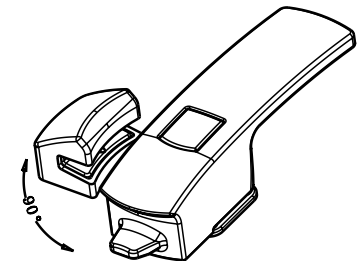

### PANEL PREPARATION

SCREWS NOT SUPPLIED: RECOMMEND M5 OR No.10 FLAT HEAD COUNTERSUNK SCREWS.

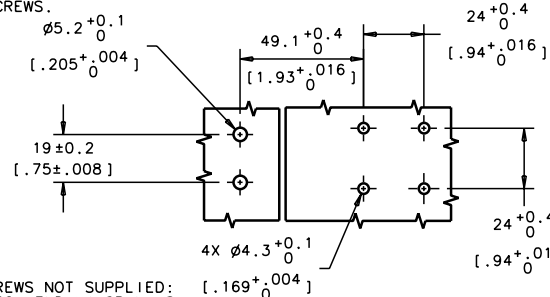

SCREWS NOT SUPPLIED: RECOMMEND M4 OR No. 8 FLAT HEAD COUNTERSUNK SCREWS.

ASSEMBLY	TM-10-101-24	SEE NOTE A	SEE NOTE A	
ITEM	PART NUMBER	MATERIAL	FINISH	
	THIRD ANGLE PROJECTION			
	MILLIMETERS [IN]			
	ALL DIMENSIONS WITHOUT TOLERANCES ARE FOR REFERENCE ONLY.	TITLE	SMALL TRANSOM SWIM LATCH	
PROPRIETARY ITEM	PER ASME Y14.5M-1994	SIZE	SYSTEM	DWG NO.
EXCEPT FOR USES EXPRESSLY GRANTED IN WRITING, INFORMATION DISCLOSED HEREIN IS CONFIDENTIAL AND ALL RIGHTS, PATENT AND OTHERWISE ARE RESERVED BY SOUTHCO, INC.		A3	IDEAS	J-TM-10-101
		DRAWN BY	DATE	SCALE
		RLR	10APR2008	.5:1
				SHEET 1 OF 1