

Item description/product images

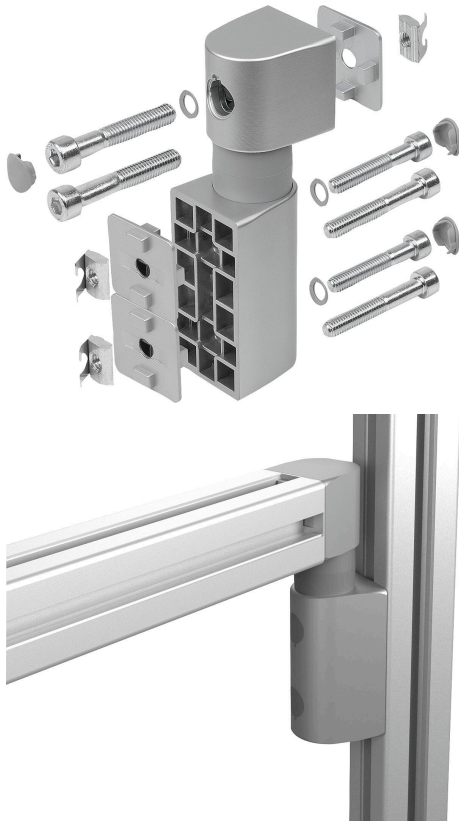

Description

Material:

Housing: die-cast aluminium.
 Inserts and friction shaft: steel.
 Cover ring and end cap: plastic.
 Slot fastening plate: die-cast aluminium.
 Screws, washers and slot keys: steel.

Version:

Housing: painted aluminium tone
 Inserts and friction shaft: bright.
 Cover rings and end caps: similar to RAL 7042.
 Slot fastening plate: painted aluminium tone.
 Screws, washers and slot keys: electro zinc-plated.

Note:

Friction joint for constructing individual swivel arms with the aid of aluminium profiles. These friction joints are characterised by a fixed friction torque that is available in 6 settings from 0.5 to 15 Nm. Rotates through 360°. Grid pitch 40 mm.

The friction joint can be attached to the profile lengthways, crossways or on the front. For front face mounting, there must be an M8 thread (min. 15 mm deep) in the core hole. When mounting on a flat face, the supplied slot fastening plates can simply be omitted.

The maximum torque M is 70 Nm.

For self-tapping threaded inserts to insert into the $\varnothing 10.2$ mm core hole to make an M8 threaded hole, see 10228-01.

Supplied with:

- 1 Friction joint
- 3 End caps
- 3 DIN EN ISO 4762 (DIN 912) screws - M8x45 (for slot key)
- 3 DIN EN ISO 4762 (DIN 912) screws - M8x50 (for core hole)
- 3 Washers 8-FSt
- 3 Slot fastening plates
- 3 Slot keys - slot 10 - M8

Drawings

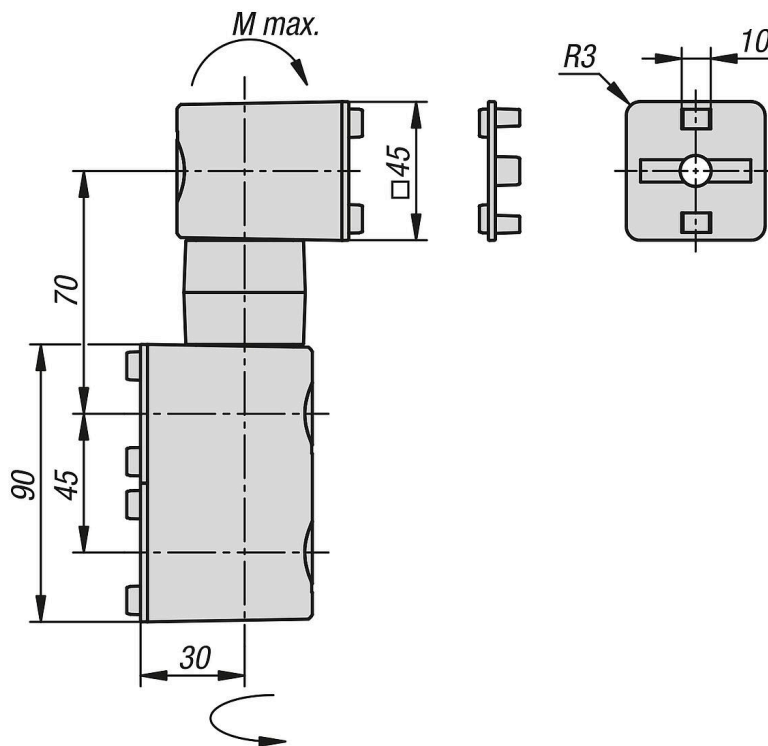

Overview of items

Order No.	Type	Slot width	Torque Nm	M Nm
10271-27-005	B	10	0,5	70
10271-27-030	B	10	3	70
10271-27-060	B	10	6	70
10271-27-090	B	10	9	70
10271-27-120	B	10	12	70
10271-27-150	B	10	15	70