

Knurled knobs

**Material:**

Black thermoplastic.

Bush and screw grade 5.8 steel.

Version:

Steel trivalent blue passivated.

Sample order:

nlm 06266-41067 (wheel cap colour colza yellow)

Note for ordering:

Δ Add the desired cap colour here.

No colour code is required for black grey caps.

Drawing reference:

Form D: tapped bush without cap





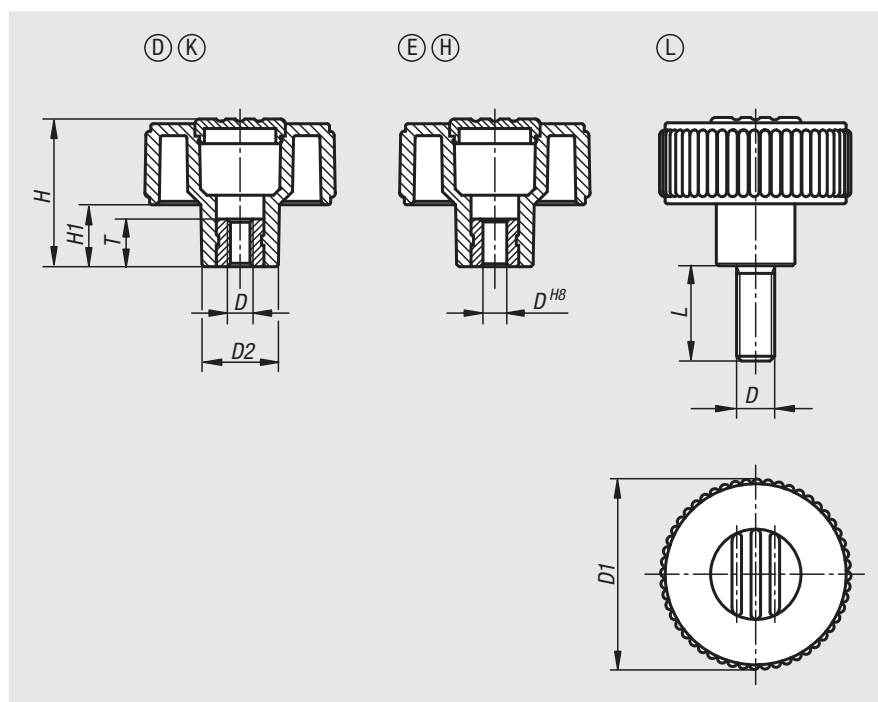

Form K: tapped bush with cap

Form E: reamed bush without cap

Form H: reamed bush with cap

Form L: external thread



black grey  RAL 7021	pure orange Δ = 1  RAL 2004	signal green Δ = 2  RAL 6032	traffic blue Δ = 3  RAL 5017
light grey Δ = 5  RAL 7035	traffic red Δ = 6  RAL 3020	colza yellow Δ = 7  RAL 1021	

Order No.	Form	D	D1	D2	H	H1	T
06266-1105	D	M5	40	16,5	30	13	10
06266-1106	D	M6	40	16,5	30	13	10
06266-1108	D	M8	40	16,5	30	13	14
06266-1208	D	M8	50	18	35	15	14
06266-1210	D	M10	50	18	35	15	14
06266-1310	D	M10	63	22	40	17	14
06266-1312	D	M12	63	22	40	17	18

Knurled knobs



Order No.	Form	D	D1	D2	H	H1	T
06266-2105Δ	K	M5	40	16,5	31	13	10
06266-2106Δ	K	M6	40	16,5	31	13	10
06266-2108Δ	K	M8	40	16,5	31	13	14
06266-2208Δ	K	M8	50	18	36	15	14
06266-2210Δ	K	M10	50	18	36	15	14
06266-2310Δ	K	M10	63	22	41	17	14
06266-2312Δ	K	M12	63	22	41	17	18

Order No.	Form	D	D1	D2	H	H1	T
06266-3106	E	6	40	16,5	30	13	10
06266-3208	E	8	50	18	35	15	14
06266-3310	E	10	63	22	40	17	14

Order No.	Form	D	D1	D2	H	H1	T
06266-4106Δ	H	6	40	16,5	31	13	10
06266-4208Δ	H	8	50	18	36	15	14
06266-4310Δ	H	10	63	22	41	17	14

Order No.	Form	D	D1	D2	H	H1	L
06266-5105ΔX	L	M5	40	16,5	31	13	10/20/40
06266-5106ΔX	L	M6	40	16,5	31	13	10/20/40
06266-5108ΔX	L	M8	40	16,5	31	13	15/30/60
06266-5208ΔX	L	M8	50	18	36	15	15/30/60
06266-5210ΔX	L	M10	50	18	36	15	20/30/60
06266-5310ΔX	L	M10	63	22	41	17	20/30/60
06266-5312ΔX	L	M12	63	22	41	17	30/60