

Hold-down clamps

pneumatic

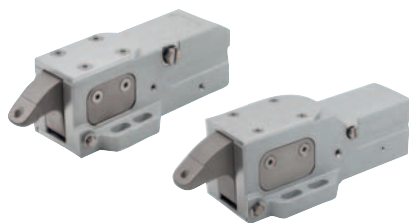

Material:

Housing aluminium.
Clamping arm steel.

Version:

Housing anodised.
Clamping arm black oxidised.

Sample order:

nIm 04624-090

Note:

The pneumatic hold-down clamp is suitable for clamping workpieces from above. This clamp is operated with standard pressure compressed air. The large swivel angle of the clamping arm makes it easy to insert and remove the workpieces without any obstructions, guaranteeing optimum accessibility to the workpiece. The block design of the housing offers universal fastening possibilities, which means that the clamp can be optimally adapted to the workpiece being clamped. Self-aligning pads with a smooth or serrated faces can be fitted in the clamping arm, enabling rough or machined workpieces to be clamped. These pneumatic clamps can be placed in multiple positions on the workpiece and operated in any particular order. They can be controlled manually or automatically. As these clamps are pneumatically actuated, they relieve the operator, particularly where frequent clamping processes are carried out.

The clamping forces indicated are based on 0.5 MPa.

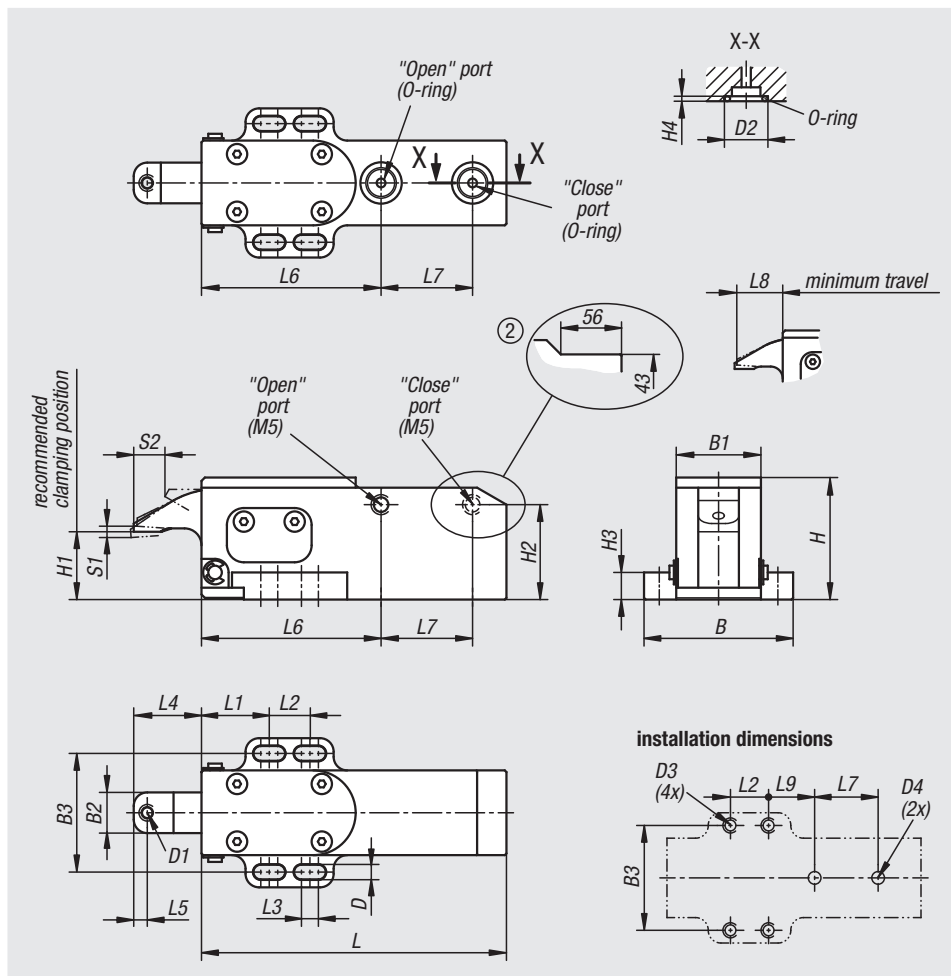

Order No.	Size	B	B1	B2	B3	D	D1	D2	D3	D4	H	H1	H2	H3	H4
04624-090	1	44	25	12	35	4,5	M4	12,2	M4	2-4	36	20	28	8	1,9
04624-135	2	65	40	18	53	6,5	M6	18	M6	2-6	54	30	33	12	2,4

Order No.	L	L1	L2	L3	L4	L5	L6	L7	L8	L9	S1 (travel)	S2	F=Retaining force N	Operating pressure MPa
04624-090	90	20	12	5	20	4	53	27	19	21	2	9	140	0,3 - 1,0
04624-135	135	30	20	8	32	6	84	38	30,5	34	3	15	320	0,3 - 1,0

Hold-down clamps

pneumatic

The clamping mechanism increases the clamping force by 150% compared to a pneumatic cylinder of the same size.

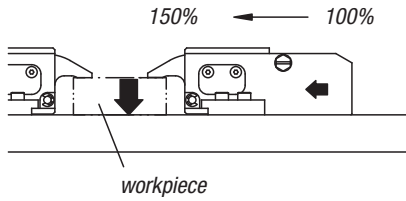

The clamping arm is operated via a wedge mechanism. If the air pressure drops due to an air leak, the wedge mechanism prevents the clamping force from dropping rapidly.

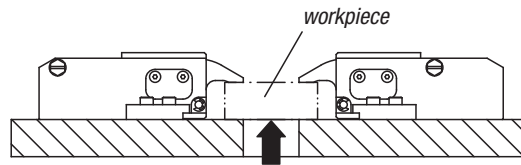

Permissible counterforce (per clamping element)

Size	Permissible clamping force (kN)
1	1
2	2,2

Use side clamp within the clamping travel.

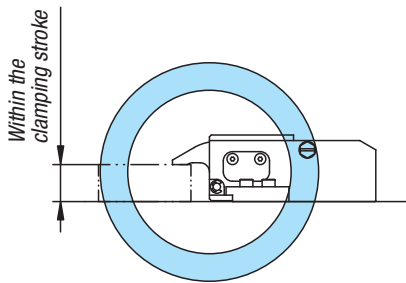

The wedge mechanism is used to clamp the workpiece securely in place.

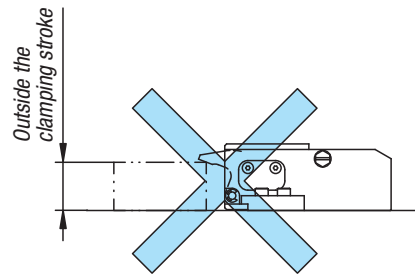

The wedge mechanism will not function.

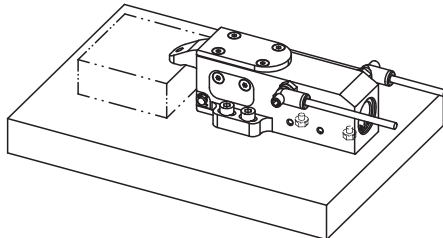

Side port as shown. Lower ports must be sealed.

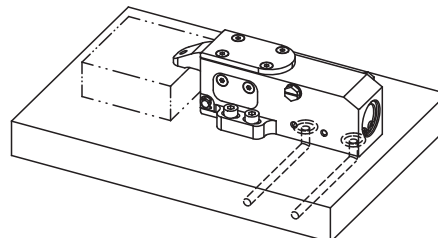

Connection from below. The side ports must be sealed.

Performance curve

