

Knurled knobs

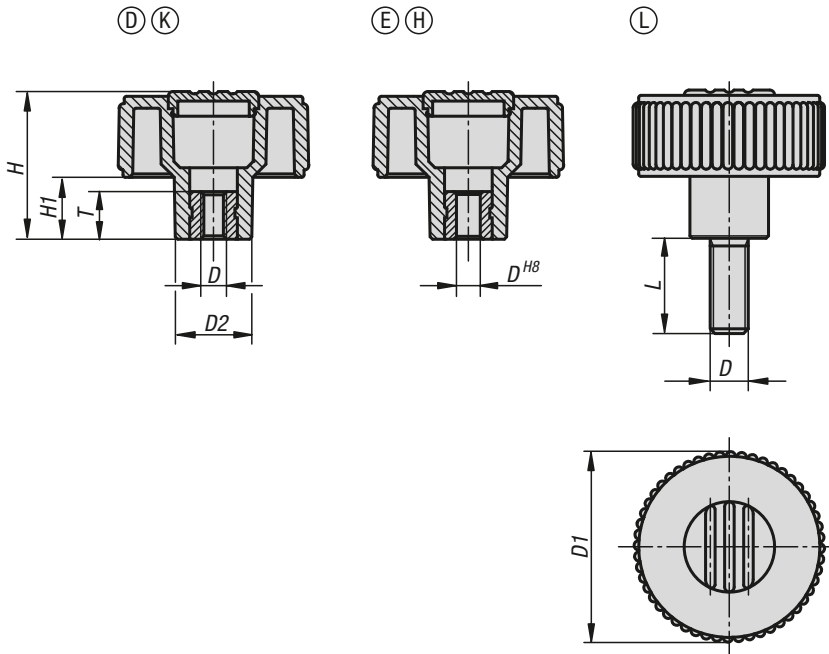

Material:

Black thermoplastic.
Bush and screw grade 5.8 steel.

Version:

Steel trivalent blue passivated.

Sample order:

K0260.41067
(cap colour colza yellow.)







Note for ordering:

Δ Add the desired cap colour here.

No colour code is required for black grey caps.

Drawing reference:

- Form D: tapped bush without cap
- Form K: tapped bush with cap
- Form E: reamed bush without cap
- Form H: reamed bush with cap
- Form L: external thread

black grey  RAL 7021	pure orange Δ = 1  RAL 2004	signal green Δ = 2  RAL 6032	traffic blue Δ = 3  RAL 5017
light grey Δ = 5  RAL 7035	traffic red Δ = 6  RAL 3020	colza yellow Δ = 7  RAL 1021	

KIPP Knurled knobs Form D, with tapped bush, without cap

Order No.	Form	D	D1	D2	H	H1	T
K0260.1105	D	M5	40	16,5	30	13	10
K0260.1106	D	M6	40	16,5	30	13	10
K0260.1108	D	M8	40	16,5	30	13	14
K0260.1208	D	M8	50	18	35	15	14
K0260.1210	D	M10	50	18	35	15	14
K0260.1310	D	M10	63	22	40	17	14
K0260.1312	D	M12	63	22	40	17	18



KIPP Knurled knobs Form K, with tapped bush, with cap

Order No.	Form	D	D1	D2	H	H1	T
K0260.2105Δ	K	M5	40	16,5	31	13	10
K0260.2106Δ	K	M6	40	16,5	31	13	10
K0260.2108Δ	K	M8	40	16,5	31	13	14
K0260.2208Δ	K	M8	50	18	36	15	14
K0260.2210Δ	K	M10	50	18	36	15	14
K0260.2310Δ	K	M10	63	22	41	17	14
K0260.2312Δ	K	M12	63	22	41	17	18

KIPP Knurled knobs Form E, with reamed bush, without cap

Order No.	Form	D	D1	D2	H	H1	T
K0260.3106	E	6	40	16,5	30	13	10
K0260.3208	E	8	50	18	35	15	14
K0260.3310	E	10	63	22	40	17	14

KIPP Knurled knobs Form H, with reamed bush, with cap

Order No.	Form	D	D1	D2	H	H1	T
K0260.4106Δ	H	6	40	16,5	31	13	10
K0260.4208Δ	H	8	50	18	36	15	14
K0260.4310Δ	H	10	63	22	41	17	14

KIPP Knurled knobs Form L, with external thread

Order No.	Form	D	D1	D2	H	H1	L
K0260.5105ΔX	L	M5	40	16,5	31	13	10/20/40
K0260.5106ΔX	L	M6	40	16,5	31	13	10/20/40
K0260.5108ΔX	L	M8	40	16,5	31	13	15/30/60
K0260.5208ΔX	L	M8	50	18	36	15	15/30/60
K0260.5210ΔX	L	M10	50	18	36	15	20/30/60
K0260.5310ΔX	L	M10	63	22	41	17	20/30/60
K0260.5312ΔX	L	M12	63	22	41	17	30/60