

Knurled knobs

with arrow



Material:

Knurled knob thermoplastic.
Washer aluminium.

Version:

Knurled knob black grey.
Washer, black anodised.

Sample order:

K0249.1055 (cap colour light grey)

Note:





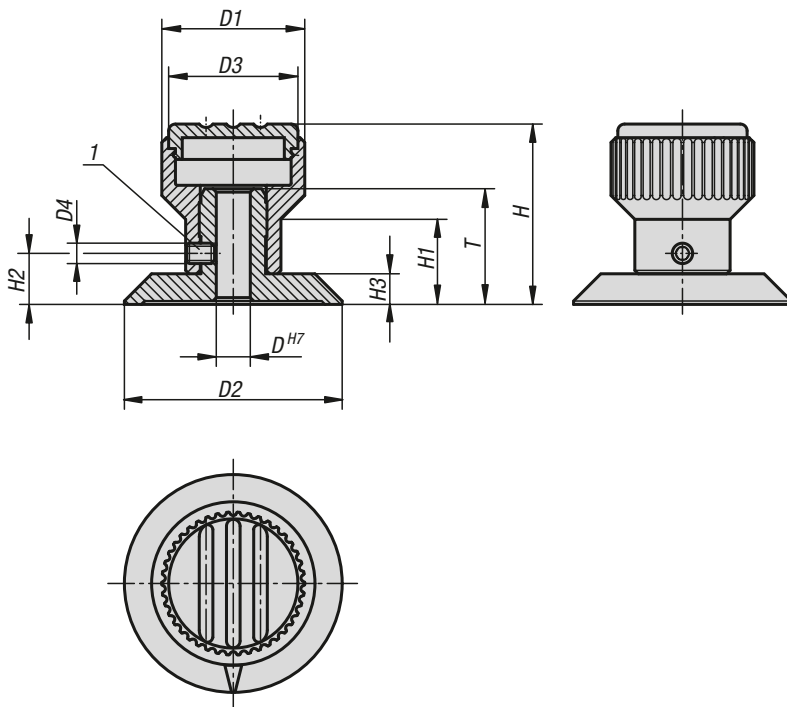

The arrow is engraved after anodizing. The set screw secures both the hub and the pressed-in washer. The H7 hole in the hub ensures a good tight fit on the shaft.

Δ Add the desired cap colour here. No colour code is required for black grey caps.

Drawing reference:

1) set screw



black grey  RAL 7021	pure orange Δ = 1  RAL 2004	signal green Δ = 2  RAL 6032	traffic blue Δ = 3  RAL 5017
light grey Δ = 5  RAL 7035	traffic red Δ = 6  RAL 3020	colza yellow Δ = 7  RAL 1021	

KIPP Knurled knobs with arrow

Order No.	D	D1	D2	D3	D4	H	H1	H2	H3	T
K0249.105Δ	5	21	32	19	M3	26,5	12,5	7,5	4,5	17
K0249.206Δ	6	26	40	23	M4	31,5	15	9,5	5,5	20,5
K0249.308Δ	8	34	52	31	M4	43	20	12	7	22