

Latches adjustable

fastening holes covered

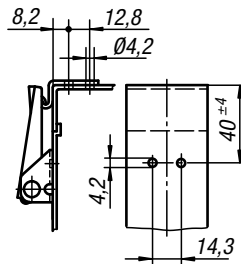
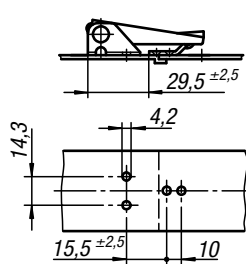
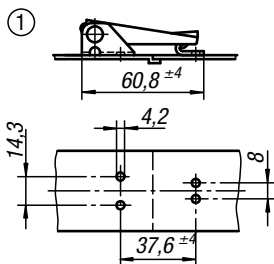
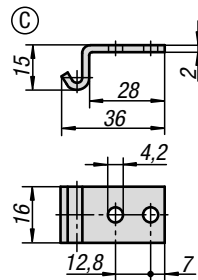
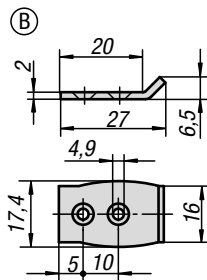
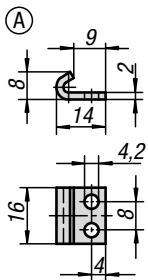
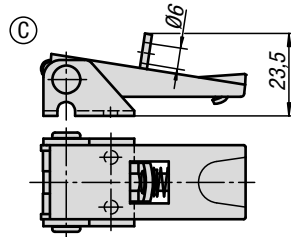
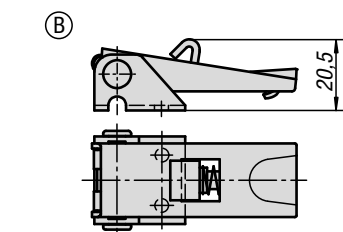
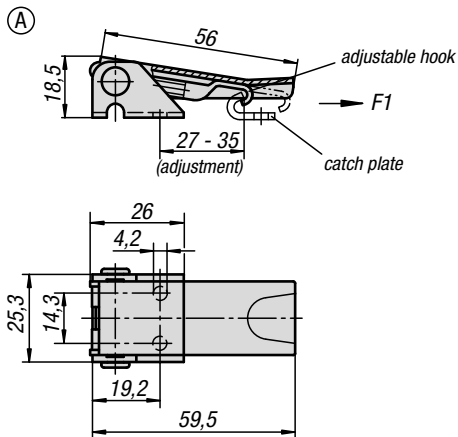

Material:

Steel or stainless steel 1.4301.

Version:

Steel trivalent blue passivated.
Stainless steel bright.

Sample order:

Latch K0047.1420601
Catch plate K0046.9142141

Note:

Adjustable latches are secure locking systems for industrial applications. By exceeding the dead centre they resist vibration.

After the hook is engaged with the catch plate, the parts to be locked can be drawn together by up to 5 mm by pushing the lever down.

To compensate for tolerances or to create enough tension, the hook length can be adjusted using the M5 threaded spindle.

The latches can be screwed down or riveted.

Any catch plate can be combined with any latch.

Order required catch plate version separately.

The retaining force F1 applies to the latch, not the catch plate.

Drawing reference:

Form A standard
Form B with safety catch
Form C with padlock bracket

1) Hole arrangements for assembly with catch plate

KIPP Latches adjustable, fastening holes covered

Order No. steel	Order No. stainless steel	Form	Retaining force F1 N
K0047.1420601	K0047.1420602	A	1000
K0047.2420601	K0047.2420602	B	1000
K0047.3420601	K0047.3420602	C	1000

KIPP Catch plates

Order No. steel	Order No. stainless steel	Form
K0046.9142141	K0046.9142142	A
K0046.9242271	K0046.9242272	B
K0046.9342381	K0046.9342382	C